

ASSEMBLY INSTRUCTIONS



Model: 1589



WARNING! ENTRAPMENT OR CRUSHING RISK

Ensure there is no person, animal or item obstructing the area under the footrest before operating this device. Only operate when the device is within your line of sight.



SAFETY INSTRUCTIONS

Please read these instructions carefully before operating.

- Ensure there is no person, animal or item obstructing the area under the footrest before operating this product. Only operate when the device is within your line of sight.
- Improper use or installation may result in the risk of fire, electric shock and/or injury. We assume no liability for any eventual damages caused by improper use or inappropriate handling, or by any other non-compliance with the instructions in this manual.
- This product is not intended for use by persons (including children) with reduced physical, sensory or mental capabilities, or lack of experience and knowledge, unless they have been given supervision or instruction concerning use of the product by a person responsible for their safety.
- Children should be supervised to ensure that they do not play with the product.
- This product contains moving parts. Keep fingers, hair and body parts well clear from moving parts. To reduce the risk of injury, keep children and pets clear of the product when in use.
- Do not sit or place additional weight on the arms, back or open footrest.
- This product is very heavy. Only move this product by lifting the main body. Never drag by the footrest, back or arm rest.
- Return this product to the full upright position to exit safely and prevent a tripping hazard.
- Do not operate this product if damage is visible in any form.
- Do not modify or use unauthorised substitute parts.
- This product has been designed and intended for indoor residential use only. It is not suitable for commercial or outdoor use.
- This product is not intended to be used as part of a health care plan. Consult your medical professional before operating if you are taking medication or have physical limitations.
- Do not exceed the maximum 120kg weight limit for this product.



ELECTRICAL SAFETY

Please read these instructions carefully before operating.

- Never force the back or footrest to close faster than the electric motor.
- Before commencing cleaning or maintenance, ensure this product is disconnected from the power outlet and back is in the full upright position.
- Disconnect this product from the power outlet before moving.
- Cease operation and disconnect from the power outlet if you ever detect a burning odour or smoke coming from the product.
- Do not operate this product if liquid spillage occurs on or around it. Disconnect from the power outlet and allow product to completely dry before reconnecting.
- Do not operate the power functions or charge station with wet hands.
- Check the condition of the power cord, electrical cords, transformer, plug and connector on a monthly basis. Do not operate if wear is visible.
- Ensure the power cord, electrical cords and transformer are clear of moving parts and not trapped underneath the base.
- Position the power cord to minimise a tripping hazard.
- Never attempt to open or disassemble electrical components.
- We recommend the use of a surge protector (not included).

3 Seater

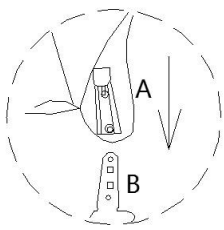
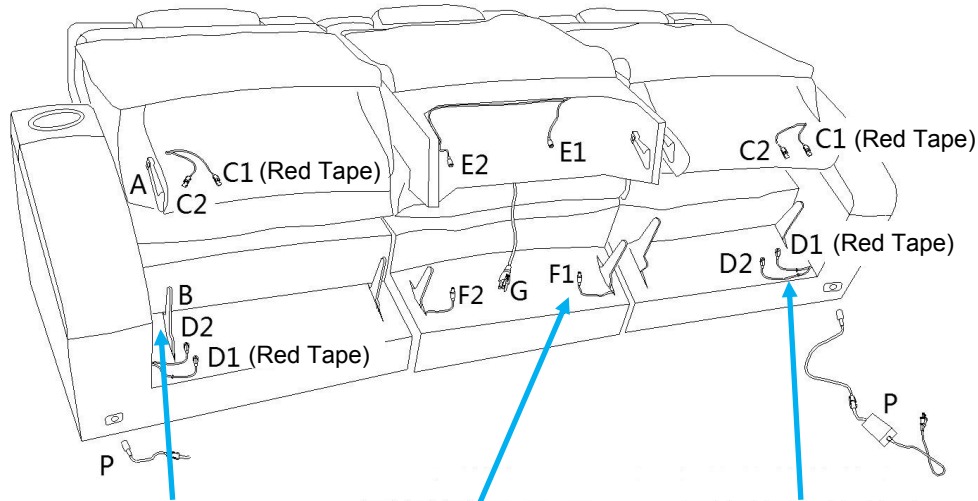

Figure 1

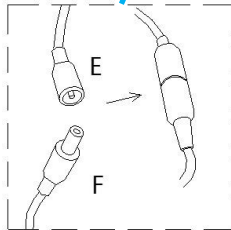

Figure 2

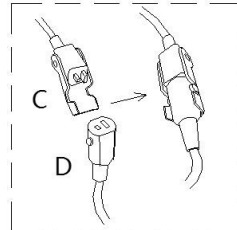
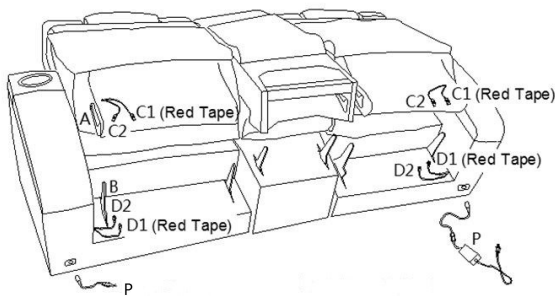
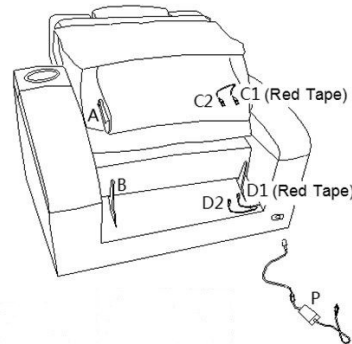

Figure 3

2 Seater



Recliner



ASSEMBLY INSTRUCTIONS

Please read these instructions carefully before assembling.

1. Attach the seat backs to the base by sliding the metal receivers **A** over the metal posts **B** (Figure 1). Ensure both sides align before pushing down firmly to lock in place. The seat backs are heavy. Ask for help if you need assistance aligning the posts and receivers. Repeat across all seat backs. The console back on the 2 Seater is packed under the console.
2. Locate the power cords **C1** and **C2** attached to the seat back and the power cords **D1** and **D2** at the rear of the seat base. Connect **C1** to **D1** and **C2** to **D2** (Figure 3). **C1** and **D1** can be identified by the red tape.
3. On the middle seat (3 Seater ONLY), locate the light cords **E1** and **E2** attached to the seat back and connect to plugs **F1** and **F2** at the rear of the seat base (Figure 2).
4. Locate the power cord **G** (3 Seater ONLY) and plug into a power outlet.
5. Check all connections are firm and secure before velcroing down the flaps on the backs of all seats.
6. Locate the transformer **P** and connect to the DC port at the rear of each arm. Plug the transformer into a power outlet. The 3 Seater and 2 Seater have a transformer for each arm. The recliner only has one transformer.
7. Your suite is now assembled and ready to be switched on at the power outlet. Please read the safety instructions before operating.
8. Follow the steps in the App Operation Instructions to download and connect your suite to the Smart Comfort App.

TROUBLESHOOTING

If you are having any issues please try the following solutions.

- Unplug the suite for 5 minutes to reset all electrical components.
- Turn your phone off and on.
- Uninstall and reinstall the Smart Comfort App on your phone.
- Check that all plugs are plugged into a power outlet and are secure. Please check that the power outlet is switched on. Try plugging the suite into a different power outlet.
- Check to ensure that all connection cords are properly connected, as per the step by step instructions. There are multiple connections, any of which being too loose may cause performance issues.
- Ensure no cords are pulled too tight. If the cord does not reach its destination with ease you may be trying to plug it into the wrong location. Please refer back to the step by step instructions to double check. If it is still too short/tight, please contact the store you purchased the suite from.
- Ensure there is nothing obstructing the recliner movement.
- Ensure the correct back is on the correct base – Eg: left back is on left base.
- The USB ports on the charge station are low voltage. Please use the 240V socket if you are charging a larger device or require a faster charge.
- Please check all connections before contacting the store for more help.

If the suite continues to fail please contact the store from which it was purchased from.

OPERATION INSTRUCTIONS

Functionality on this product is controlled from the Smart Comfort App. Please refer to the App Operation Instructions for detailed instructions. The App can be downloaded using the links below.



Scan QR Code
Above for Apple iOS App Store
or search Smart Comfort by Synargy



Scan QR Code
Above for Android Google Play Store
or search Smart Comfort by Synargy

Manual Operation

Power Recline, Power Lumbar and Power Headrest can be manually operated from the hand controller on the inside of the arm.

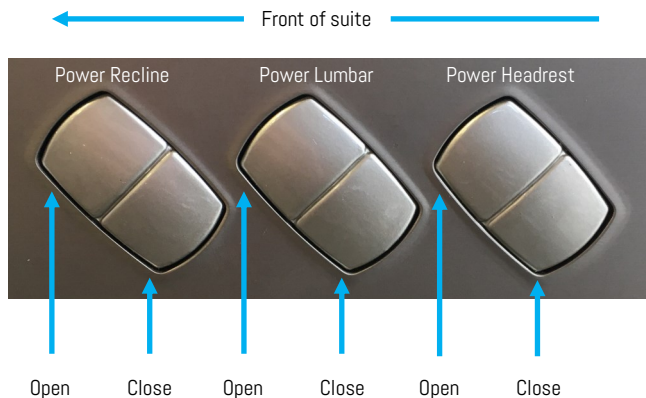

USB Charger (2 Seater and Recliner Only)

A USB Charger is located in the arm of the Recliner and in the console of the 2 Seater. There are 2 USB ports. Connect a device to automatically begin charging.



Tray Table (2 Seater Only)

The 2 Seater includes a removable tray table which is stored in the arm rest. Insert the pin on the tray table into the grommet at the front of the console. The tray table is rotatable. Please note the maximum weight that can be placed on the tray table is 5kgs.



Charge Station (3 Seater Only)

A Charge Station is located in the drop down table of the 3 seater. There are 2 x 240V outlets and 2 x USB ports. The light above the USB ports will glow green when ready to charge and red when a device is connected and charging.

For larger devices such as tablets and laptops, we recommend using the 240V outlets to charge.



LED Lights

The LED Base Lights, LED Cup Holder Lights and LED Reading Lights can only be operated via the Smart Comfort App. Refer to the App Operation Instructions for details on operation. Lights will automatically turn off 1 hour after last operation.

Synargy is a registered responsible supplier on ERAC. Electrical components within our products have been tested and comply with all legal requirements imposed for electrical safety and EMC.

synargy[®]
Furniture that fits your life